

Datasheet

Description

Conc. red., DIN2616/EN10253-2-B
P235GH, certificate 3.1

Main data

88.90 x 3.20 / 76.10 x 2.90 mm

D	88.90 mm
S1	3.20 mm
d	76.10 mm
S2	2.90 mm
L	90.00 mm

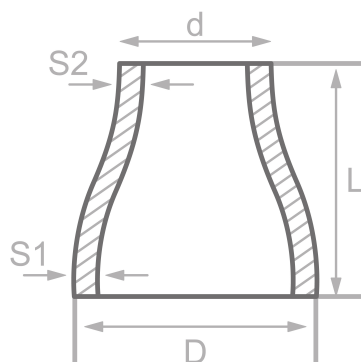

Chemical analysis (heat) in % of mass

(one content=max. value)

Short name: P235GH

Mat. grade: 1.0345

C	Si	Mn	P	S	Cr	Cu	Mo	Nb	Ni	Ti	V	Others
0.16	0.35	1.20	0.025	0.020	0.30	0.30	0.08	0.01	0.30	0.04	0.02	Al

Mechanical properties

Short name: P235GH

Mat. grade: 1.0345

Upper yield strength reH or Rp0.2 min for wallthicknesses T in mm, N/mm2 at room temperature		Tensile strength Rm for wallthickn. T in mm, N/mm2 at room temperature		Elongation A at room- temperature, min.%		Min. impact energy KV in J	
T<=16	16<T<=60	T<=16	16<T<=60	Longit.	Transv.	Longit.	Transv.
235	225	360-500	360-500	25	23	40	27

Sources: EN 10253, DIN 17175, DIN 2528, DIN 1629, Stahlschlüssel, ASTM